

# HFAGRO PLOWS



AGRICULTURAL ENGINEERING COMPANY

## **QUALITY PLOWING WITHOUT COMPROMISE**

HFagro plows of the HF-111 series provide the highest quality of plowing in any soil conditions and at the same time with maximum comfort for the tractor driver.

Maximum convenience, a great selection of options and accessories, mechanical and hydraulic adjustments, reliable multi-stage reversible protection is (and much more) - HFagro reversible plows.



## PROTECTION SYSTEMS

HFagro plows can be equipped with various protection and regulation systems.

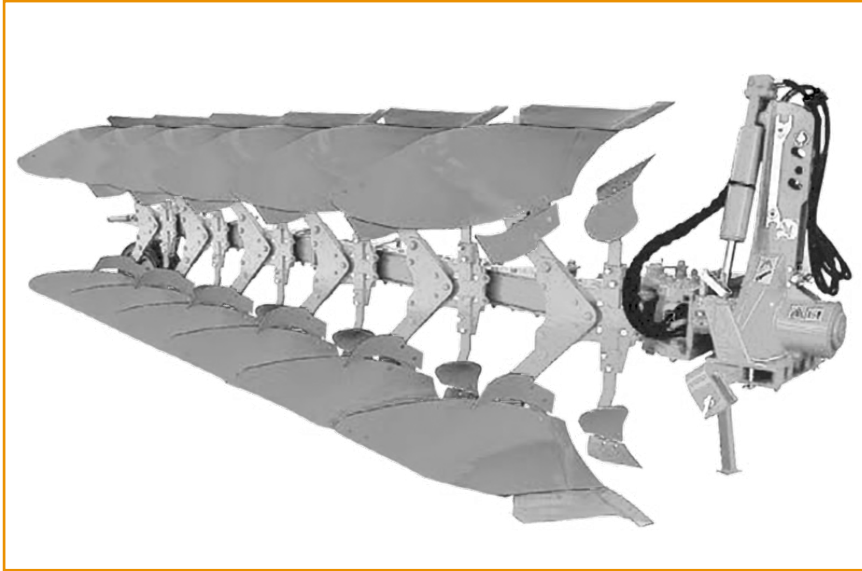

### SHEAR BOLT PROTECTION

Bolt shearing force is 3,000 kg

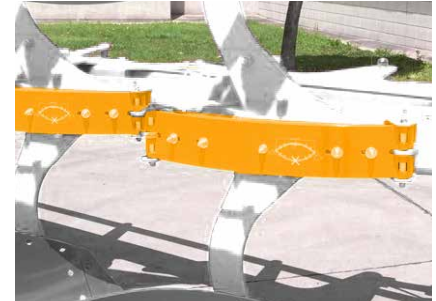

### LEAFSPRING PROTECTION

Its reliability and effectiveness are well proven. When the plow body rises above the obstacle, the pressure of the leaf spring decreases, this function leads to the minimum pressure on the plow frame.

Double protection: in all plows with this protection system the racks are bolted to the beam; not welded. One of these mounting bolts is intended as shear bolt, so they function as an optional non-stop system.



### HYDRAULIC PROTECTION

It allows the pressure to be adapted to the soil conditions. In heavy or compacted soil, the pressure may be increased to maintain the penetration level and optimal position of the working organs. Conversely, in rocky conditions, the pressure can be set lower so that stones do not hit the surface.

Similar to the plows with spring protection, the racks are also bolted to the beam and not welded, which provides double protection.

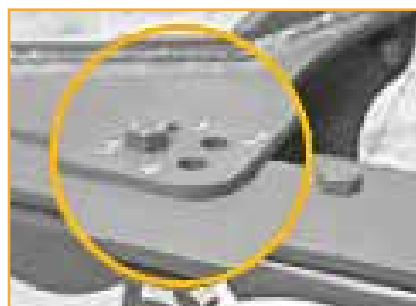

### MANUAL WIDTH ADJUSTMENT

The working width can be adjusted manually by simply repositioning the support bolt to another hole in the beam.

There are 4 different working widths available: 35 cm, 40 cm, 48 cm, and 53 cm.



### HYDRAULIC WIDTH ADJUSTMENT

Working width can be adjusted hydraulically from the tractor cab from 30 to 50 cm per body.

Automatic memory system: plows HFagro come standard with an automatic memory system.

The system extends the main frame up to minimum width to ensure smooth rolling and in order to avoid hitting the ground with the rear end of the plow. The plow then automatically returns to the original working width.

## REVERSIBLE SEMI-MOUNTED PLOWS

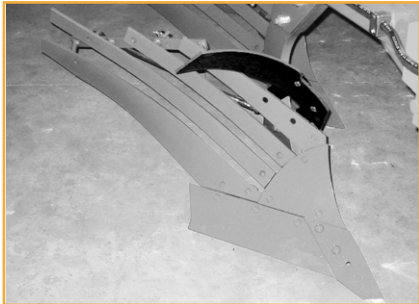

VARIETY OF SHARE KNIVES AVAILABLE



FULL LINE OF ASSESSORIES



HYDRAULIC WHEEL FOR DEPTH ADJUSTMENT

### ADVANTAGES

- Possibility to work on-land or in-furrow with the same plow.
- Standard hydraulic adjustment width of the 1st furrow.
- Large wheel 500/45 22.5" is supplied in a standard set.

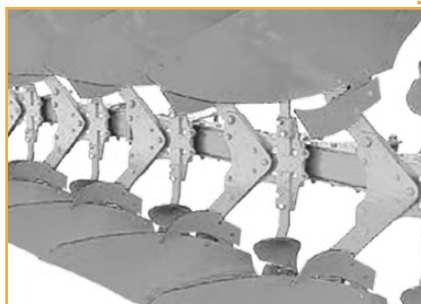
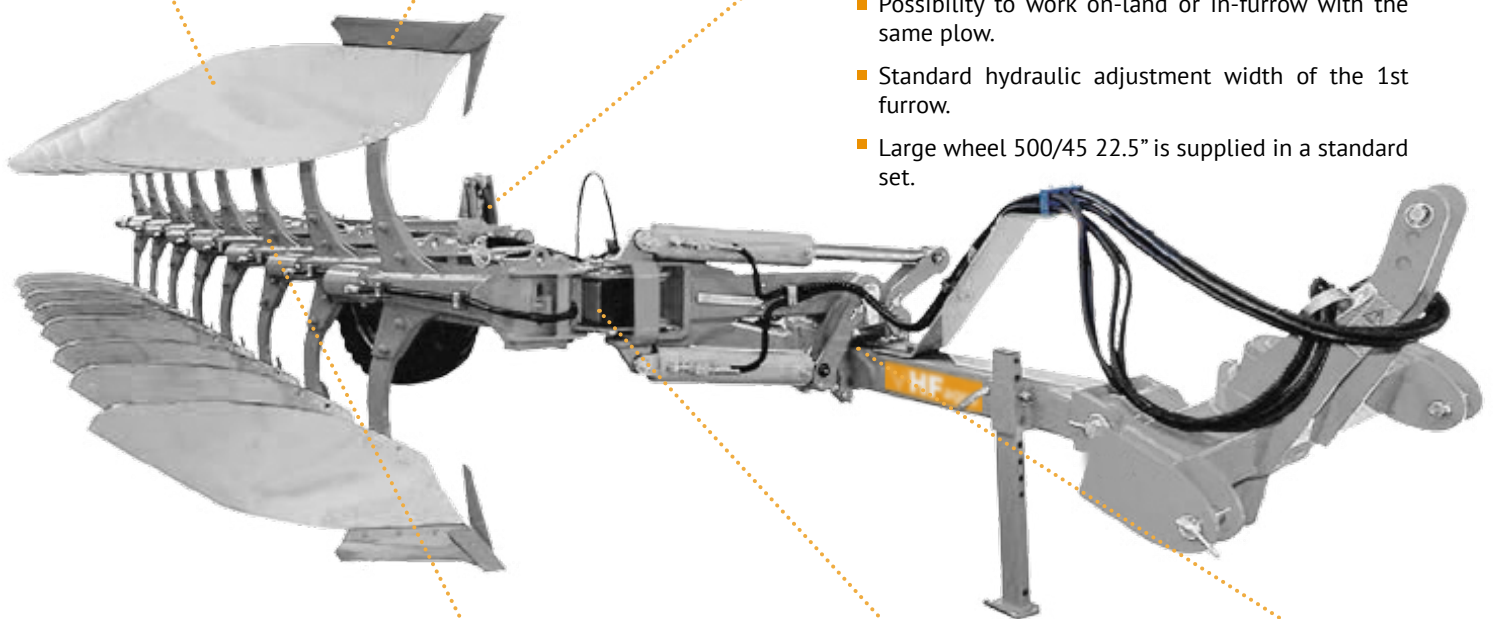

3 PROTECTION TYPES

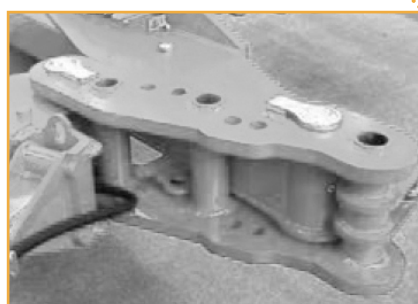

ON-LAND/ IN FURROW OPTIONS



STANDARD HYDRAULIC WIDTH ADJUSTMENT OF THE 1ST FURROW

## TECHNICAL CHARACTERISTICS

HFagro plows are available with a different amount of bodies (from 5 to 8), and each plow can be completed with additional working units.

Each HFagro plow can be supplied with mechanical or hydraulic width adjustment, and with any of the three types of protection.

Width adjustment	Mechanical	Hydraulic
Working width, cm	35, 40, 48, 53	30 - 53
Protection	Shear bolt, spring or hydraulics	
Distance between working bodies, cm	105	
Clearance under the beam, cm	72, 78, or 90	
Frame, mm	150x150	
Rear wheel	500/45 22.5 "hydraulics	
Front wheel	only in on-land version: 250/65 14.5 "12 pr	
1st furrow adjustment	Hydraulic (standard)	

SHEAR BOLT

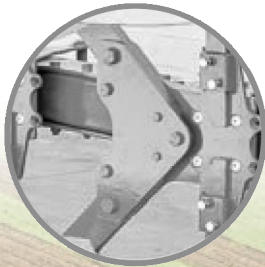

LEAFSPRING



HYDRAULIC



## OPTIONS



1 MAIZE SKIMMERS



2 LARGE CAPACITY SKIMMERS



3 GRASS SKIMMERS



4 AUTO RESET DISC COULTERS



5 SPRING LOADED DISC COULTERS

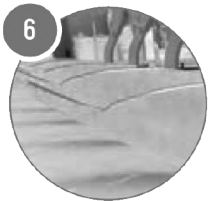

6 MOULDBOARD PRESSES

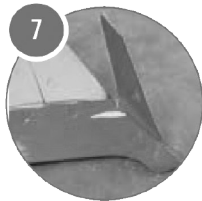

7 SHARE KNIVES



8 LANDSLINE EXTENSIONS

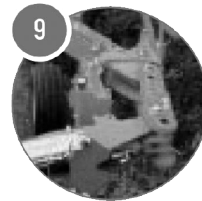

9 IN-THE-FURROW VERSION



10 TRASH BOARDS

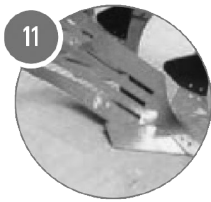

11 SLATTED MOULDBOARDS



12 V-90 MOULDBOARDS



13 V-90 MOULDBOARDS

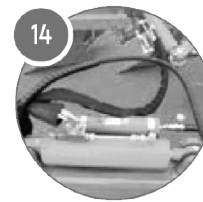

14 SHOCK ABSORPTION FOR TRANSPORT



17 FURROW WIDENERS



18 ELECTRIC COMMAND TO CONTROL 2 HYDRO FUNCTIONS WITH 1 SPOOL VALVE





[WWW.HFAGRO.COM.UA](http://WWW.HFAGRO.COM.UA)

Marshala Batitskogo str 8,  
Kharkiv, 61038, Ukraine

[office@hfagro.com.ua](mailto:office@hfagro.com.ua);  
+38 (050) 301-42-80